



# RG-AP880-L

Wi-Fi 6E Indoor  
Tri-radio Access Point

# 01

## Product Overview

The RG-AP880-L is an 802.11ax-compliant tri-radio wireless access point (AP) provided by Ruijie Networks for general education, higher education, government, finance, business, and other indoor scenarios.

It complies with 802.11ax, 802.11ac Wave2, 802.11ac Wave1, and 802.11n. With a hardware-independent tri-radio design, the RG-AP880-L adopts the hardware-independent Tri-radio design and can provide a data rate of up to 7.780 Gbps. The ultra-fast wireless rate eliminates the performance bottleneck.

The RG-AP880-L supports Wi-Fi 6E technology and makes full use of 6GHz spectrum resources to provide customers with a smoother network experience while

ensuring efficient transmission of key business data.

The design of the RG-AP880-L considers factors such as wireless network security, radio control, mobile access, QoS, seamless roaming, and Internet of Things (IoT) scalability. With Ruijie's access controller (AC), the RG-AP880-L can implement wireless client data forwarding, security features, access control, and IoT application extension.

The RG-AP880-L supports both local power supply and Power over Ethernet (PoE), so customers can flexibly select the power supply. It can be installed against a wall or ceiling, which is suitable for deployment in scenarios such as large campuses, conference centers, enterprise offices, and operational hotspots.

# 02

## Product Appearance



# 03

## Product Highlights

- Tri-radio design (2.4GHz + 5 GHz + 6 GHz), eight spatial streams, and up to 7.780 Gbps peak data rate
- 6 Gbps wired data rate to achieve high-speed wireless data backhaul, and access through optical and Ethernet cables for flexible networking
- OFDMA and MU-MIMO, optimizing multi-user access experience
- IEEE 802.11k/v/r support, roaming stickiness optimization, and remote association for better user experience
- WPA3, Enhanced Open Security, 802.1X, and other encryption authentication to enhance data security
- Local and cloud management (free for life) modes, and intelligent wireless network optimization, reducing TCO and maximizing ROI
- Rich IoT features: PoE output, Bluetooth 5.1, and wireless locating

# 04

## Product Features

### Wi-Fi 6E Technology

The RG-AP880-L supports Wi-Fi 6E technology and makes full use of 6 GHz spectrum resources to provide customers with a smoother network experience while ensuring efficient transmission of key business data.

### Multiple Service Ports

The RG-AP880-L supports up to 6 Gbps wired access.

- One auto-negotiation Ethernet electrical port provides up to 5 Gbps wired access to implement high-speed transmission and conversion between wireless and wired networks.
- One auto-negotiation Ethernet electrical port provides up to 1 Gbps wired access to achieve high-speed transmission and conversion between wireless and wired networks. Furthermore, it can expand other modules such as the IoT module to adapt to more application scenarios.
- One LAN1/5GE SFP port, supporting various wired connections and data transmission through the 5GE SFP port.

### High-speed Wireless Access for Better Experience

The RG-AP880-L optimizes user experience by maximizing Wi-Fi utilization and substantially reducing airtime competition between clients. It provides Orthogonal Frequency-Division Multiple Access (OFDMA), Multiple-Input Multiple-Output (MIMO) and BSS color. With up to 4 spatial streams (4SS) and 160 MHz channel bandwidth (HE160), the RG-AP880-L delivers the data rate of up to 4.804 Gbps at 6 GHz band, providing pioneering wireless capabilities for enterprises.

### 1024-QAM High-Speed Access

The RG-AP880-L adopts the tri-radio design and complies with Wi-Fi standard IEEE 802.11ax. When three radios are enabled, it can provide a wireless data rate of up to 7.780 Gbps to realize high-speed access experience.

### OFDMA High-Density User Access

OFDMA in IEEE 802.11ax enables the RG-AP880-L to divide a WLAN channel into multiple narrower sub-

channels, with each user occupying one or more sub-channels. The RG-AP880-L can schedule services of multiple users, and receive and send packets concurrently. This reduces contention for air interface resources and backoff, shortens the network latency, and improves the network efficiency.

### MU-MIMO

The RG-AP880-L supports multi-user MIMO (MU-MIMO) to maximize the use of MU-MIMO, which can effectively improve the throughput of a wireless network by exchanging data with multiple single-stream or dual-stream client devices simultaneously.

### Seamless Switching

The RG-AP880-L supports Hotspot 2.0 of Wi-Fi Association (WFA) and automatic identity recognition, providing clients with seamless cellular-to-Wi-Fi switching.

### Diverse Wi-Fi Technologies

It supports RF transmission technologies:

- Dynamic frequency selection (DFS): The device configured with DFS can detect the signals of the same frequency in the environment and dynamically switch the operating frequency to prevent interference from radar signals.
- Cyclic delay/shift diversity (CDD/CSD) improves downlink RF performance, and converts spatial diversity to frequency diversity to avoid intersymbol interference, thus reducing bit error rate (BER) and effectively reducing signal distortion.
- Maximum ratio combining (MRC) improves the signal quality at the receiving end and enhances reliability and performance of received signals.

It supports RF channel coding technologies:

- Space-time block coding (STBC) increases the range and improves signal receiving, and enhances reliability of data transmission.
- Low-density parity check (LDPC) corrects errors efficiently and improves the throughput.
- Transmit beam-forming (TxBF) expands the signal coverage and enhances the reliability of specific devices, thereby improving the data rate.

## Intelligent Optimization, Reliability Guarantee

### Intelligent Recognition, One-Click Network Optimization

The RG-AP880-L can intelligently identify mobile terminals such as iOS and Android Clients and PCs. It can be used to implement visualized wireless network management based on the wireless client type and optimize a network in one-click mode. The RG-AP880-L embeds client experience measurement and environment collection capability. It can be used with RG-WS wireless access control for intelligent analysis and automatic RF resource scheduling. It can adjust the RF power and intelligently allocate channels to solve problems such as co-channel interference, adjacent channel interference, and roaming stickiness.

### Intelligent Local Forwarding

The RG-AP880-L integrates intelligent local forwarding technology and eliminates the traffic bottleneck on its connected AC. The data forwarding mode of the RG-AP880-L can be flexibly pre-configured through Ruijie's AC. Then, the RG-AP880-L determines whether data needs to be forwarded by the AC or be sent to a wired network for data exchange based on the SSID or user VLAN.

With the local forwarding technology, the RG-AP880-L classifies delay-sensitive data that requires real-time transmission, and forwards it through a wired network. This greatly relieves the traffic burden of the AC and better adapts to heavy-traffic transmission on 802.11ax networks.

### Client Access Optimization

The RG-AP880-L can dynamically measure parameters such as the uplink Received Signal Strength Indicator (RSSI), noise floor, and channel utilization to intelligently identify the client network status. Moreover, it can steer clients to preferentially connect to 5 GHz, 6 GHz or APs with better experience. This solves the problems of roaming stickiness, remote association, and load imbalance, and improves user experience.

### Advanced Network Coexistence

The RG-AP880-L supports advanced network coexistence. It uses the built-in filter to automatically minimize the impact of interference from non-Wi-Fi network devices.

### Abundant QoS Policies

The RG-AP880-L provides abundant QoS policies. It

supports bandwidth limiting based on the WLAN, AP, and STA, and provides Wi-Fi Multimedia (WMM) that defines priorities for different service data. Therefore, it implements immediate and quantitative transmission of audio and video data, and guarantees smooth application of multimedia services.

The multicast-to-unicast technology supported by the RG-AP880-L solves the video freezing problem caused by packet loss or long latency in Video on Demand (VoD) and other multicast applications on a wireless network. It enhances the experience in the use of multicast video services on a wireless network.

## Intelligent Monitoring, Green Design, and Power Saving

### Intelligent Power Monitoring

- The RG-AP880-L can monitor the PoE output power and disable or enable some functions according to the available power to ensure its normal operation.
- When powered by 802.3at, the RG-AP880-L starts up normally, but its downlink port and USB port cannot provide power for external devices.
- When powered by 802.3af, the RG-AP880-L starts up normally. All RF cards can only work in one-stream mode, and the downlink port and USB port cannot provide power for external devices.

### Energy Saving and Lower Power Consumption

The RG-AP880-L incorporates packet-based power control technology. With high-performance power design, the RG-AP880-L is energy-efficient while providing high-speed wireless access services.

## Rich IoT Platform Features

The RG-AP880-L integrates Bluetooth 5.1 to simplify deployment and management of IoT-based location services, asset tracking services, security solutions, and IoT sensors. It allows access through Bluetooth serial ports.

The RG-AP880-L supports PoE output, providing flexible expansion and reliable power supply for IoT devices such as IP phones, cameras, set-top boxes (STBs), and smart audio devices. This eliminates re-cabling in the ELV room and dependence on AC power.

## Comprehensive Security Protection and Ease of Use

### Multiple Easy-to-Use Authentication Modes

The RG-AP880-L supports various authentication

and encryption technologies, including web, 802.1X, WEP (64/128 bits), WPA, WPA2, WPA3, voucher code, user accounts, SMS, and PSK. WPA3 includes WPA3-Personal, WPA3-Enterprise, and WPA3-OWE. In compliance with standard Network Access Control (NAC), the AC offers control policies through authentication, authorization, device compliance check, and network attack detection or prevention. All these features guarantee high network security for authenticated users.

## Flexible Device Management Modes

### Flexible Switching Between Fit and Fat Modes

The RG-AP880-L supports flexible switchover among fat, fit and cloud deployment modes. When the RG-AP880-L is deployed in fat and cloud mode, it can operate as a single device and be managed by the local access controller (AC). It can also be connected to the Ruijie public for cloud-based management. When the RG-AP880-L is deployed in fit mode, it can be used with the AC to achieve more functions. In fit mode, the AP can be deployed through Zero Touch Provisioning (ZTP). In addition, complete remote management also greatly enhances the O&M

management efficiency of a wireless network.

### Eweb Management

The RG-AP880-L provides the Eweb for AC and AP management. O&M personnel can complete wireless configuration easily and manage the wireless network in an all-round manner. On the AC Eweb, O&M personnel can manage an AP as well as clients connected to the AP. The rate limits and network access behaviors of clients can be defined, allowing the O&M personnel to plan, operate, and maintain a wireless network easily.

### Mobile Monitoring and Optimization

You can use the free Ruijie Cloud mobile app to achieve simple network management experience. This app features unified device lifecycle management for APs, switches, and security gateways. The app also simplifies device provisioning, monitoring, configuration, and optimization. For details, visit official website at <https://www.ruijienetworks.com/products/smb/cloud-service/cloud-service/ruijie-cloud-solution/mobile-app>.

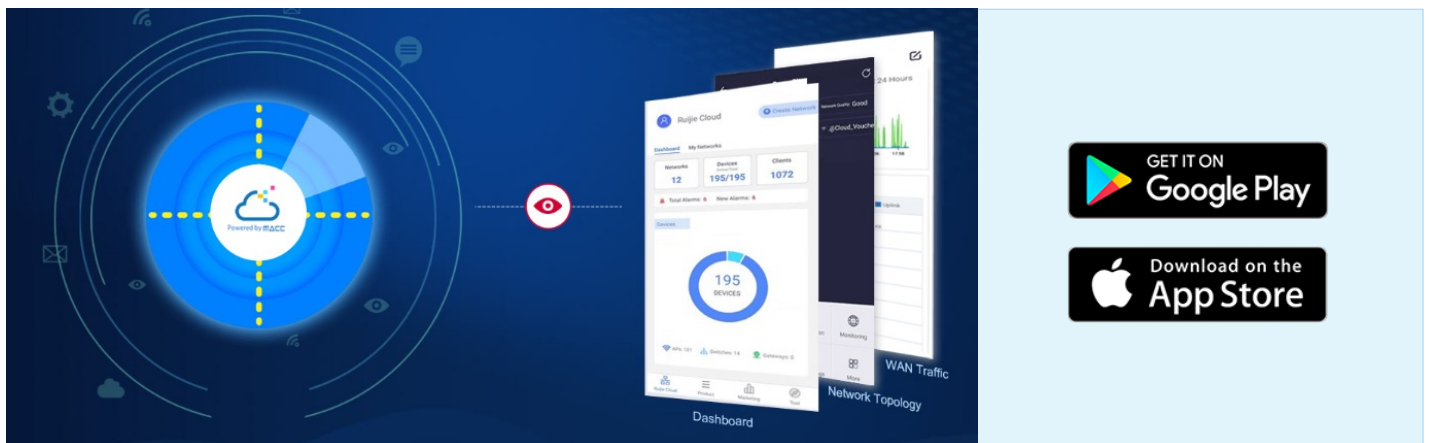

## All-in-One for Small Branch Office

In small branch office scenarios, the RG-AP880-L serves as an AP to provide the wireless access service for the office area, and also functions as a VPN gateway. This all-in-one design simplifies network deployment and saves building costs.

### PPPoE

The RG-AP880-L can function as a PPPoE client and connects to the Internet through PPPoE. In this case, no gateway needs to be deployed in a branch office

area for Internet access.

### NAT

The RG-AP880-L supports the Network Address Translation (NAT) function to translate addresses between the LAN in the branch office and the Internet.

### IPsec VPN

The RG-AP880-L can establish IPsec VPN tunnels between the headquarters and branch offices to implement LAN interconnection.

# 05 Specifications

## Hardware Specifications

### Dimensions and Weight

Dimensions and Weight	RG-AP880-L
Unit dimensions (W x D x H)	230 mm x 230 mm x 51 mm (9.06 in. x 9.06 in. x 2.01 in.)
Shipping dimensions (W x D x H)	284 mm x 262 mm x 124 mm (11.18 in. x 10.31 in. x 4.88 in.)
Unit weight	Main unit: 1.0 kg (2.20 lbs) Mounting bracket: 0.1 kg (0.22 lbs)
Shipping weight	1.25 kg (2.76 lbs)
Mounting	Wall/Ceiling-mount (a mounting bracket is delivered with the main unit)
Lock option	Kensington lock and securing latch

### Wi-Fi Radio

Wi-Fi Radio	RG-AP880-L
Radio design	Tri-radio and up to eight spatial streams: <ul style="list-style-type: none"> <li>Radio 1: 2.4GHz: Two spatial streams, 2x2 MU-MIMO</li> <li>Radio 2: 5GHz: Two spatial streams, 2x2 MU-MIMO</li> <li>Radio 3: 6GHz: Four spatial streams, 4x4 MU-MIMO</li> </ul>
Operating frequencies	Radio 1: 802.11b/g/n/ax <ul style="list-style-type: none"> <li>2.400 GHz to 2.483 GHz, channels 1 to 13</li> </ul> Radio 2: 802.11a/n/ac/ax <ul style="list-style-type: none"> <li>5.150 GHz to 5.250 GHz, U-NII-1, channels 36, 40, 44, and 48</li> <li>5.250 GHz to 5.350 GHz, U-NII-2A, channels 52, 56, 60, and 64</li> <li>5.470 GHz to 5.725 GHz, U-NII-2C, channels 100, 104, 108, 112, 116, 120, 124, 128, 132, 136, and 140</li> <li>5.725 GHz to 5.850 GHz, U-NII-3/ISM, channels 149, 153, 157, 161, and 165</li> </ul> Radio 3: 802.11ax <ul style="list-style-type: none"> <li>5.925 GHz to 7.125 GHz, U-NII-4, channels 1 to 233</li> </ul> Note: Available frequency bands may vary with countries or regions. To use the above-mentioned frequency bands, ensure that they are supported in your country or region. For details, see <a href="#">WLAN Country or Region Codes and Channel Compliance</a> .
Data rates	Combined peak data rate: 7.780 Gbps Radio 1: 2.4 GHz, 574 Mbps <ul style="list-style-type: none"> <li>Two spatial stream Single User (SU) MIMO for up to 574 Mbps wireless data rate to 2SS HE40 802.11ax client devices (maximum)</li> </ul>
Data rates	<ul style="list-style-type: none"> <li>Two spatial stream Single User (SU) MIMO for up to 287 Mbps wireless data rate to 2SS HE20 802.11ax client devices (typical)</li> <li>Radio 2: 5 GHz, 2.402 Gbps                             <ul style="list-style-type: none"> <li>Two spatial stream Single User (SU) MIMO for up to 2.402 Gbps wireless data rate to individual 4SS HE160 802.11ax client devices (maximum)</li> <li>Two spatial stream Single User (SU) MIMO for up to 1.201 Gbps wireless data rate to individual 2SS HE80 802.11ax client devices (typical)</li> </ul> </li> <li>Radio 3: 6 GHz, 4.804 Gbps                             <ul style="list-style-type: none"> <li>Four spatial stream Single User (SU) MIMO for up to 4.804 Gbps wireless data rate to individual 4SS HE160 802.11ax client devices (maximum)</li> <li>Two spatial stream Single User (SU) MIMO for up to 1.201 Gbps wireless data rate to individual 2SS HE80 802.11ax client devices (typical)</li> <li>Four spatial stream Multi User (MU) MIMO for up to 4.804 Gbps wireless data rate to up to four 1SS or two 2SS HE160 802.11ax DL-MU-MIMO capable client devices simultaneously (maximum)</li> <li>Four spatial stream Multi User (MU) MIMO for up to 2.402 Gbps wireless data rate to up to four 1SS or two 2SS HE80 802.11ax DL-MU-MIMO capable client devices simultaneously (typical)</li> </ul> </li> </ul>

Wi-Fi Radio	RG-AP880-L
Data rate set	The following 802.11-compliant data rates in Mbps are supported: 2.4 GHz <ul style="list-style-type: none"> <li>• 802.11b: 1, 2, 5.5, 11</li> <li>• 802.11g: 1, 2, 5.5, 6, 9, 11, 12, 18, 24, 36, 48, 54</li> <li>• 802.11n: 6.5 to 300 (MCS0 to MCS15, HT20 to HT40)</li> <li>• 802.11ax: 8.6 to 574 (MCS0 to MCS11, NSS = 1 to 2, HE20 to HE40)</li> </ul> 5 GHz <ul style="list-style-type: none"> <li>• 802.11a: 6, 9, 12, 18, 24, 36, 48, 54</li> <li>• 802.11n: 6.5 to 300 (MCS0 to MVC31, HT20 to HT40)</li> <li>• 802.11ac: 6.5 to 1,733 (MCS0 to MCS9, NSS = 1 to 4, VHT20 to VHT160)</li> <li>• 802.11ax: 8.6 to 2,402 (MCS0 to MCS11, NSS = 1 to 4, HE20 to HE160)</li> </ul> 6 GHz <ul style="list-style-type: none"> <li>• 802.11ax: 8.6 ~ 4,804 (MCS0 ~ MCS11, NSS = 1 to 4, HE20 to HE160)</li> </ul>
Packet aggregation	802.11n/ac/ax: A-MPDU and A-MSDU
Antenna type	Built-in omnidirectional antennas (two 2.4 GHz antennas, two 5 GHz antennas and four 6 GHz antennas)
Antenna gain	2.4 GHz: 5 dBi 5 GHz: 5 dBi 6 GHz: 5 dBi
Maximum transmit power	2.4 GHz: 27 dBm (24dBm per chain) 5 GHz: 26 dBm (23dBm per chain) 6 GHz: 26 dBm (23dBm per chain) Note: The transmit power is limited by local regulatory requirements. For details, see <a href="#">WLAN Country or Region Codes and Channel Compliance</a> . Thailand 2.400 GHz to 2.4835 GHz, EIRP ≤ 20 dBm 5.150 GHz to 5.350 GHz, EIRP ≤ 23 dBm 5.470 GHz to 5.725 GHz, EIRP ≤ 30 dBm 5.725 GHz to 5.825 GHz, EIRP ≤ 30 dBm 5.945 GHz to 6.425 GHz, EIRP ≤ 23 dBm
Power increment	Configurable in increments of 1 dBm
Radio technologies	802.11b: Direct-Sequence Spread-Spectrum (DSSS) 802.11a/g/n/ac: Orthogonal Frequency-Division Multiplexing (OFDM) 802.11ax: Orthogonal Frequency Division Multiple Access (OFDMA)
Modulation types	802.11b: BPSK, QPSK, and CCK 802.11a/g/n: BPSK, QPSK, 16-QAM, and 64-QAM 802.11ac: BPSK, QPSK, 16-QAM, 64-QAM, and 256-QAM 802.11ax: BPSK, QPSK, 16-QAM, 64-QAM, 256-QAM, and 1024-QAM

The following table lists the radio frequency performance of Wi-Fi including different frequency bands, protocols, and data rates. It is country-specific, and Ruijie Networks reserves the right of interpretation.

Radio Frequency Performance		RG-AP880-L	
Frequency Band and Protocol	Data Rate	Maximum Transmit Power per Transmit Chain	Maximum Receive Sensitivity per Receive Chain
2.4 GHz, 802.11b	1 Mbps	24 dBm	-96 dBm
	2 Mbps	24 dBm	-95 dBm
2.4 GHz, 802.11b	5.5 Mbps	23 dBm	-93 dBm
	11 Mbps	22 dBm	-89 dBm
2.4 GHz, 802.11g	6 Mbps	24 dBm	-91 dBm
	24 Mbps	23 dBm	-85 dBm
	36 Mbps	23 dBm	-80 dBm
	54 Mbps	21 dBm	-74 dBm

Radio Frequency Performance		RG-AP880-L		
Frequency Band and Protocol	Data Rate	Maximum Transmit Power per Transmit Chain	Maximum Receive Sensitivity per Receive Chain	
2.4 GHz, 802.11n (HT20)	MCS0	24 dBm	-90 dBm	
	MCS7	20 dBm	-70 dBm	
2.4 GHz, 802.11n (HT40)	MCS0	24 dBm	-90 dBm	
	MCS7	20 dBm	-70 dBm	
2.4 GHz, 802.11ax (HE20)	MCS0	24 dBm	-90 dBm	
	MCS11	16 dBm	-62 dBm	
2.4 GHz, 802.11ax (HE40)	MCS0	24 dBm	-88 dBm	
	MCS11	16 dBm	-60 dBm	
5GHz 802.11a	6 Mbps	23 dBm	-91 dBm	
	24 Mbps	22 dBm	-85 dBm	
	36 Mbps	22 dBm	-80 dBm	
	54 Mbps	21 dBm	-74 dBm	
5GHz 802.11n (HT20)	MCS0	23 dBm	-90 dBm	
	MCS7	20 dBm	-68 dBm	
5GHz 802.11n (HT40)	MCS0	23 dBm	-88 dBm	
	MCS7	20 dBm	-68 dBm	
5GHz 802.11ac (VHT20)	MCS0	23 dBm	-90 dBm	
	MCS9	18 dBm	-68 dBm	
5GHz 802.11ac (VHT40)	MCS0	23 dBm	-88 dBm	
	MCS9	18 dBm	-63 dBm	
5GHz 802.11ac (VHT80)	MCS0	23 dBm	-85 dBm	
	MCS9	18 dBm	-60 dBm	
5GHz 802.11ax (HE20)	MCS0	23 dBm	-90 dBm	
	MCS11	16 dBm	-60 dBm	
5GHz 802.11ax (HE40)	MCS0	23 dBm	-86 dBm	
	MCS11	16 dBm	-56 dBm	
5GHz 802.11ax (HE80)	MCS0	23 dBm	-83 dBm	
	MCS11	16 dBm	-53 dBm	
5GHz 802.11ax (HE160)	MCS0	23 dBm	-81 dBm	
	MCS11	16 dBm	-51 dBm	
6GHz 802.11ax (HE20)	MCS0	22 dBm	-90 dBm	
	MCS11	16 dBm	-60 dBm	
6GHz 802.11ax (HE40)	MCS0	22 dBm	-86 dBm	
	MCS11	16 dBm	-56 dBm	
6GHz 802.11ax (HE80)	MCS0	22 dBm	-83 dBm	
	MCS11	16 dBm	-53 dBm	



Radio Frequency Performance		RG-AP880-L	
Frequency Band and Protocol	Data Rate	Maximum Transmit Power per Transmit Chain	Maximum Receive Sensitivity per Receive Chain
6GHz 802.11ax (HE160)	MCS0	22 dBm	-81 dBm
	MCS11	16 dBm	-51 dBm

## Bluetooth Radio

Bluetooth Radio	RG-AP880-L
Bluetooth	Bluetooth 5.1
Antenna type	Integrated vertically polarized omnidirectional antenna
Maximum antenna gain	4.6 dBi, with roughly 30 degrees downtilt
Maximum transmit power	10 dBm (Class 1)
Receive sensitivity	-98 dBm

## Port Specifications

Port Specifications	RG-AP880-L
Fixed service port	1 x 100/1000/2.5G/5GBASE-T port <ul style="list-style-type: none"> <li>• Auto MDI/MDIX crossover</li> <li>• NBASE-T/IEEE802.3bz-compliant 5 Gbps</li> <li>• PoE-PD: 54 V DC (nominal) 802.3af/at/bt (Class 3 or higher)</li> <li>• 802.3az EEE</li> </ul> 1 x 5GE SFP/RJ45 combo port, compatibility with 1GE and 2.5GE modules 1 x 10/100/1000BASE-T port <ul style="list-style-type: none"> <li>• Supplying 48 V/12.95 W power to an IoT unit</li> <li>• Auto MDI/MDIX crossover</li> <li>• 802.3az EEE</li> </ul>
Fixed management port	1 x RJ45 console port (serial console port)
USB	USB 3.0 (Type-A connector)
Status LED	1 x multi-color system status LED
Button	1 x Reset button <ul style="list-style-type: none"> <li>• Press the button for shorter than 2 seconds. Then the device restarts.</li> <li>• Press the button for longer than 5 seconds. Then the device restores to factory settings.</li> </ul>

## Power Supply and Consumption

Power Supply and Consumption	RG-AP880-L
Input power supply	The AP supports the following two power supply modes: <ul style="list-style-type: none"> <li>• 54 V DC/1.1 A power input over DC connector: The DC connector accepts 2.1 mm/5.5 mm center-positive circular plug. A DC power adapter is delivered with the main unit.</li> <li>• PoE input over LAN 1: The power source equipment (PSE) complies with IEEE 802.3af/at/bt standard (PoE/PoE+/PoE++).</li> </ul> Note: <ul style="list-style-type: none"> <li>• If both DC power and PoE are available, DC power is preferred.</li> <li>• When powered by 802.3bt (PoE++), the AP operates with the optimal performance.</li> <li>• When powered by 802.3at (PoE+), the AP starts up normally. LAN 2 and USB port cannot supply power to external devices.</li> <li>• When powered by 802.3af (PoE), the AP starts up normally. 2.4 GHz, 5 GHz and 6 GHz radio cards can work only in one spatial stream mode . LAN 2 and USB port cannot supply power to external devices.</li> </ul>

Power Supply and Consumption	RG-AP880-L
PoE port	When powered by 802.3bt (PoE++), the LAN 2 port can source 48 V/12.95 W power to an IoT unit.
USB port	When powered by 802.3bt (PoE++), the USB port can source 1 A/5 W power to an attached device.
Overall power consumption	Maximum power consumption: 40 W DC powered: 40 W PoE powered (802.3af): 12.95 W PoE+ powered (802.3at): 23 W PoE++ powered (802.3bt): 40 W Idle mode: 10.3 W

### Environment and Reliability

Environment and Reliability	RG-AP880-L
Temperature	Operating temperature: -10°C to 50°C (14°F to 122°F) Storage temperature: -40°C to 70°C (-40°F to +158°F) Note: At an altitude in the range of 3,000–5,000 m (9,842.52–16,404.20 ft.), every time the altitude increases by 220 m (722 ft.), the maximum temperature decreases by 1°C (1.8°F).
Humidity	Operating humidity: 5% to 95% (non-condensing) Storage humidity: 5% to 95% (non-condensing)
Mean Time Between Failure (MTBF)	394,941 hours (45 years) at the operating temperature of 25°C (77°F)

### Regulatory Compliance

Regulatory Compliance	RG-AP880-L
Security regulations	IEC 62368-1 EN 62368-1
EMC regulations	EN 55032 EN 55035 EN IEC 61000-3-2 EN 61000-3-3 EN 301 489-1 EN 301 489-3 EN 301 489-17
Radio frequency regulations	EN 300 328 EN 301 893 EN 300 440 ETSI EN 303 687 EN IEC 62311 FCC Part 15

\*For more country-specific regulatory information and approvals, contact your local sale agency.

Note:

- EU simplified DoC: Hereby, [Ruijie Networks Co., Ltd.] declares that the radio equipment type [RG-AP880-L] is in compliance with Directive 2014/53/EU. The full text of the EU declaration of conformity is available at the following internet address: <https://www.ruijienetworks.com/>.
- UK simplified DoC: Hereby, [Ruijie Networks Co., Ltd.] declares that the radio equipment type [RG-AP880-L] is in compliance with UK Radio Equipment Regulation 2017. The full text of the UK declaration of conformity is available at the following internet address: <https://www.ruijienetworks.com/>.
- The functions of Wireless Access Systems including Radio Local Area Networks(WAS/RLANs) within the band 5150-5350 MHz for this device are restricted to indoor use only within all European Union countries (BE/BG/CZ/DK/DE/EE/IE/EL/ES/FR/HR/ IT/CY/LV/LT/LU/HU/MT/NL/AT/PL/PT/RO/SI/SK/FI/SE/ TR/N O/CH/IS/LI/UK(NI))

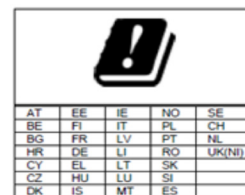

## Software Specifications

Applicable Software Version	RG-AP880-L
Applicable software version	RGOS11.9(6)W3B4 or higher

## WLAN

WLAN	RG-AP880-L
Recommended maximum number of active devices per AP	300
Maximum number of associated clients	1536 ⓘ Note The number of associated clients varies according to the environment.
Maximum number of BSSIDs	45 (up to 15 BSSIDs per radio)
STA management	SSID hiding Each SSID can be configured with the authentication mode, encryption mechanism, and VLAN attributes independently. Remote intelligent perception technology (RIPT) Intelligent client identification technology Intelligent load balancing based on the STA quantity or traffic
STA limiting	SSID-based STA limiting Radio-based STA limiting
Bandwidth limiting	STA/SSID/AP-based rate limiting
Wireless roaming	Layer 2 and Layer 3 roaming

## Security

Security	RG-AP880-L
Authentication and encryption	Remote Authentication Dial-In User Service (RADIUS) PSK, web, 802.1X, WPA, WPA2, and WPA3 authentication SMS authentication (used with the RG-WS series wireless access controller) MAB authentication (used with the RG-WS series wireless access controller) WEP (64/128 bits), WPA-Personal, WPA-Enterprise, WPA2-Personal, WPA2-Enterprise, WPA3-Personal (WPA2/WPA3 transition mode), WPA3-Enterprise (CCMP), WPA3-Enterprise (GCMP), WPA3-OWE, WPA3-OWE transition mode
Data frame filtering	Allowlist, static blocklist, and dynamic blocklist
ACL	Dynamic ACL assignment
CPP	Supported
NFPP	Supported

## Routing and Switching

Routing and Switching	RG-AP880-L
IP service	Static IPv4 address and DHCP-assigned IPv4 address NAT, FTP ALG, DNS ALG
Multicast	Multicast-to-unicast conversion
IPv6 basics	IPv6 addressing, Neighbor Discovery (ND), ICMPv6, IPv6 Ping IPv6 DHCP Client
IP routing	IPv4/IPv6 static routing
VPN	PPPoE Client IPsec VPN

## Management

Management	RG-AP880-L
Network management	Fault inspection and alarm Information statistics and logging SNMPv1/v2c/v3 NTP Server and NTP Client
Network management platform	Ruijie Cloud Web-based management (Eweb)
User access management	Console, Telnet, SSH, SNMP and TFTP-based management
Fat/Fit/Cloud mode switchover	When the AP works in Fit mode, it can be switched to Fat mode through an AC. When the AP works in Fat mode, it can be switched to Fit mode through the console port or Telnet. When the AP works in Cloud mode, it can be managed through Ruijie Cloud.

# 06

## Antenna Pattern Plots

### Horizontal Planes (Top View)

The following figures show the azimuth (0 degrees) and 30 degrees downtilt patterns (averaged patterns for all applicable antennas).

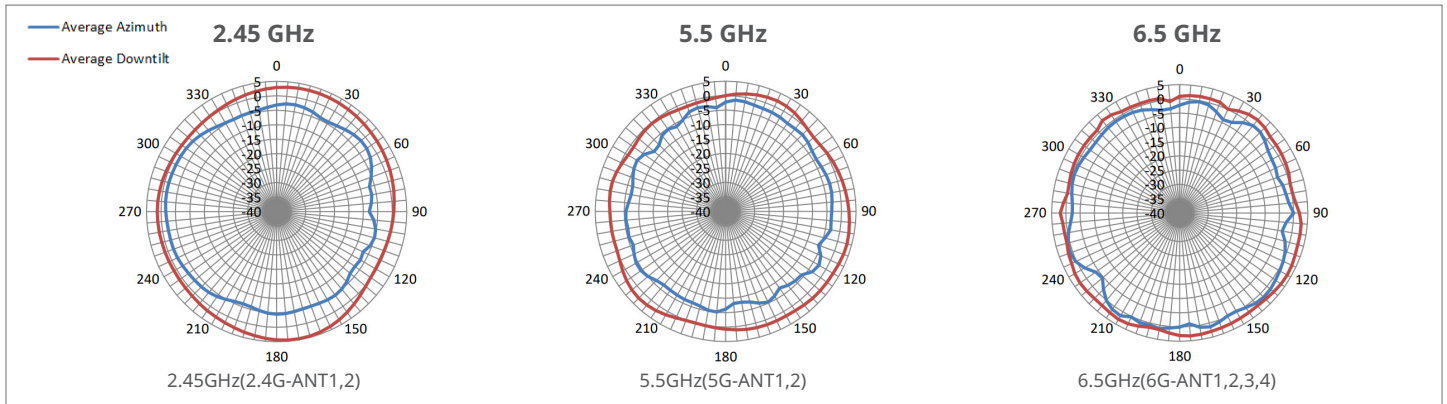

### Vertical Planes (Side View)

The following figures show the side view with AP rotated 0 and 90 degrees (averaged patterns for all applicable antennas)

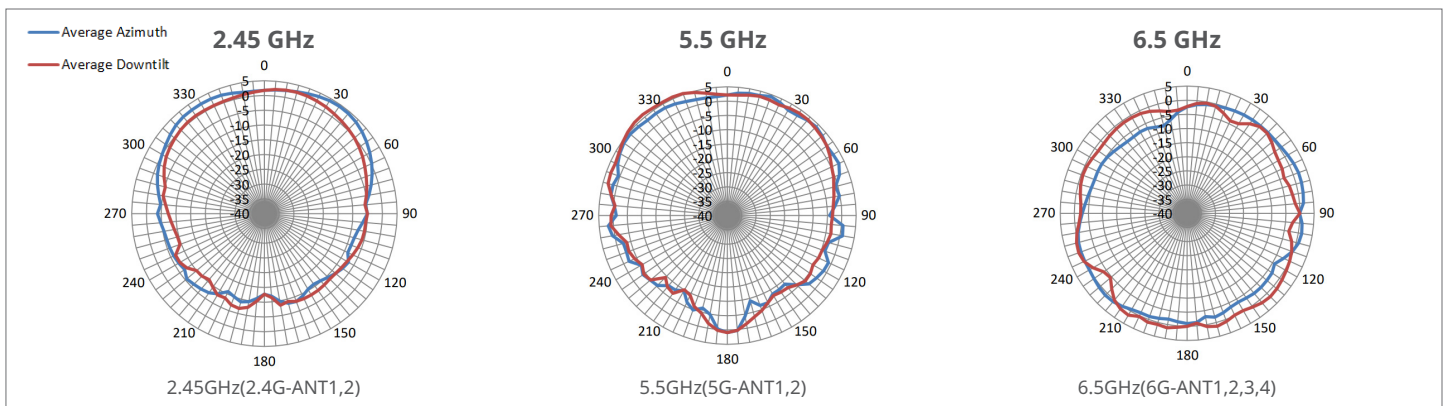

Note: Operating frequency bands are country-specific.

# 07 Typical Applications

## Typical Scenario

The AP is applicable to densely populated areas with simple building structures, no special obstructions, and a large capacity demand. Such areas include meeting rooms, libraries, classrooms, bars, and leisure centers. The AP can be flexibly deployed based on the environment.

The following figure shows the typical network topology of the RG-AP880-L.

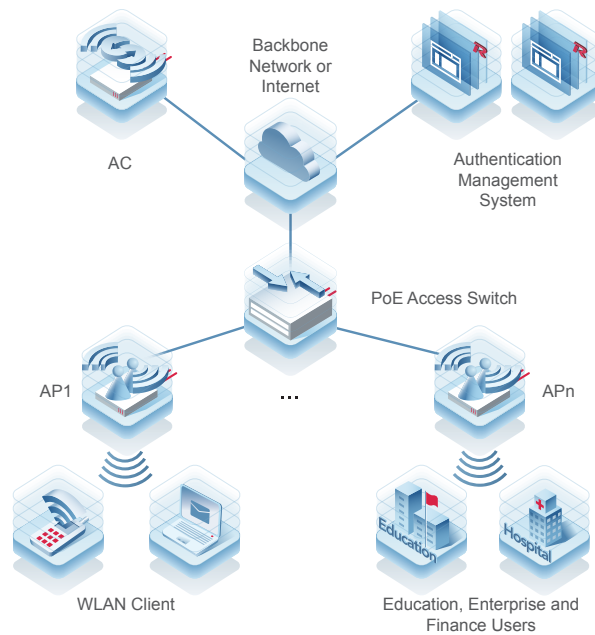

## Public Cloud Deployment

With Ruijie public cloud service, the RG-AP880-L is fit for small- and medium-scale scenarios, including offices, hotels, and retail stores. Ruijie Networks provides customers with Ruijie Cloud lifetime free licenses. It significantly streamlines the IT operational efficiency, and simplifies wireless deployment with cost-effective options for SMEs.

The Ruijie Cloud service provides network provisioning, monitoring, optimization, operation, and maintenance. Devices can be easily deployed or swapped in plug-and-play mode. Automatic RF planning meets the needs of increasing user experience.

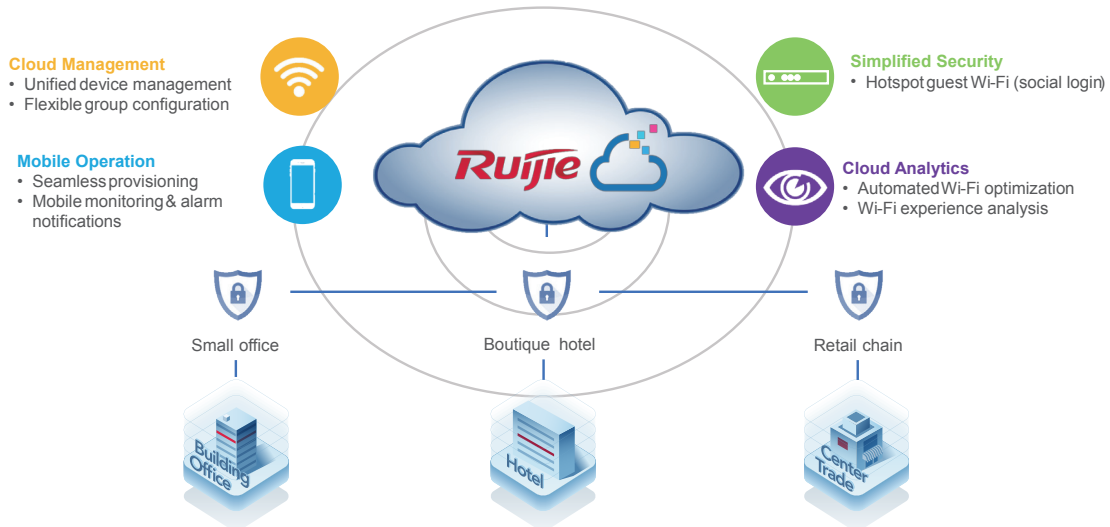

## Key Features:

- Unified device management
- Fast provisioning by Cloud and App
- Captive portal
- App-based monitoring and alarm

## Hybrid Cloud Deployment

For enterprise office, campus network, and hospitality customers with single or multiple sites, a hybrid mode consisting of Ruijie RG-WS series wireless access controller (on-premises) and cloud-based management (optional) is recommended for high-density AP deployment. Wireless access controllers are installed at the customer's site with fully integrated wireless management and authentication features, supporting large-scale AP management with cluster-based controller architecture. Optionally, the cloud management platform allows for value-added features such as centralized device configuration and monitoring and reporting.

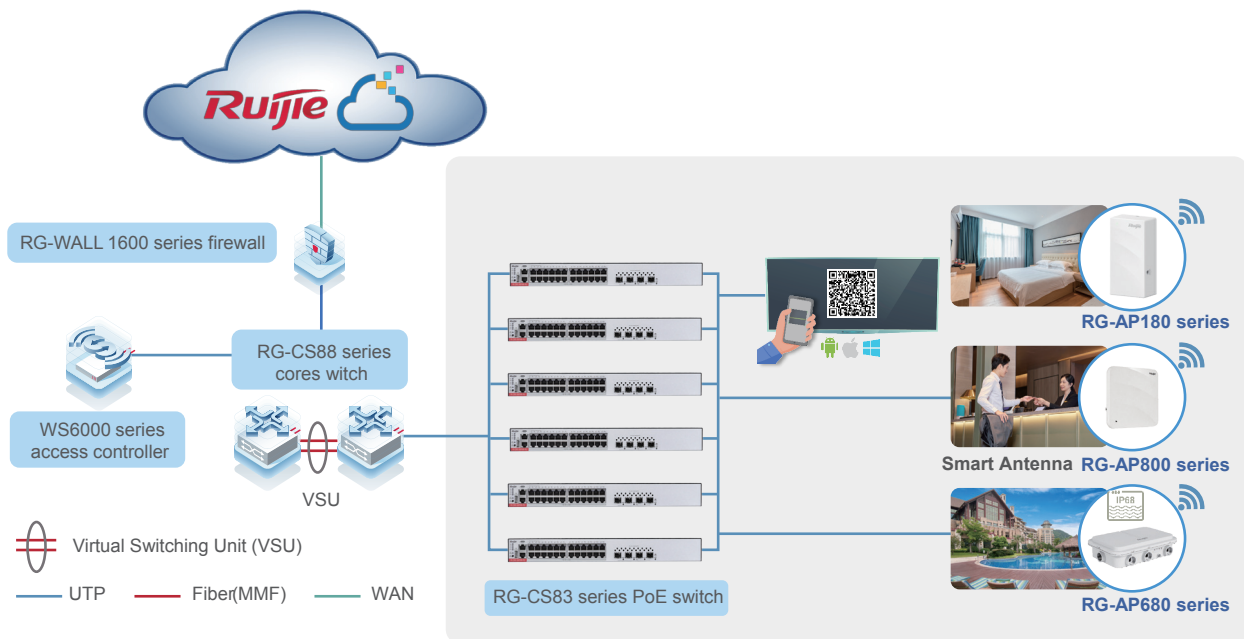

## Key Features:

- Centralized device management and reporting by Ruijie Cloud
- Ultra-seamless roaming management
- High performance and security with all user authentication and traffic forwarding handled locally
- Flexible authentication options, including 802.1X and voucher authentication
- Unified management of all series of Ruijie APs

Note: For more applicable scenarios, contact Ruijie pre-sales engineers.

# 08

## Ordering Information

Model	Description
RG-AP880-L	Wi-Fi 6E tri-radio wireless access point 2.4 GHz 2 x 2:2 MU-MIMO + 5 GHz 2 x 2:2 MU-MIMO + 6 GHz 4 x 4: 4 MU-MIMO Built-in omnidirectional antennas Up to eight spatial streams Data rate of up to 7.780 Gbps Compliance with IEEE 802.11a/b/g/n/ac and 802.11ax Fat/fit/cloud mode switchover Compliance with IEEE 802.3 bt/at/af PoE standard Each AP occupying one wireless controller license

# 09

## Package Contents

Item	Quantity
RG-AP880-L access point	1
Mounting bracket	1
Wall anchor	4
4.2 mm x 20 mm Phillips pan head self-tapping screw	4
Warranty card and hazardous substance table	1
User manual	1

# 10

## Warranty

For more information about warranty terms and period, contact your local sales agency:

- Warranty terms: <https://www.ruijienetworks.com/support/servicepolicy>
- Warranty period: <https://www.ruijienetworks.com/support/servicepolicy/Service-Support-Summary/>

Note: The warranty terms are subject to the terms of different countries and distributors.

# 11

## More Information

For more information about Ruijie Networks, visit the official Ruijie website or contact your local sales agency:

- Ruijie Networks official website: <https://www.ruijienetworks.com/>
- Online support: <https://www.ruijienetworks.com/support>
- Hotline support: <https://www.ruijienetworks.com/support/hotline>
- Email support: [service\\_rj@ruijienetworks.com](mailto:service_rj@ruijienetworks.com)
- *WLAN Country or Region Codes and Channel Compliance*: [https://www.ruijienetworks.com/support/documents/slide\\_wlan-country-codes-overview](https://www.ruijienetworks.com/support/documents/slide_wlan-country-codes-overview)



**Copyright ©2000-2023 Ruijie Networks Co., Ltd. All rights reserved.**

No part of this document may be reproduced or transmitted in any form or any means without prior written consent of Ruijie Networks Co., Ltd.

**Notice**

This content is applicable only to regions outside the China mainland. Ruijie Networks Co., Ltd. reserves the right to interpret this content.

The information contained herein is subject to change without notice. Nothing herein should be construed as constituting an additional warranty. Ruijie Networks Co., Ltd. shall not be liable for technical or editorial errors or omissions contained herein.



Ruijie Networks Co., Ltd  
Website: <https://www.ruijienetworks.com>